

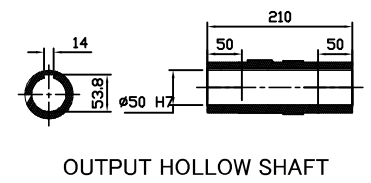

REDUCER SPEC	
MODEL	IB103
RATIO	1/8.89~1/165.25
OUTPUT R.P.M	
OUTPUT TORQUE	
MOUNTING POSITION	B3
WEIGHT	59 KG

MOTOR SPEC	
MODEL	
POWER	
POLE, PHASE	
VOLTAGE	
INPUT R.P.M	
BRAKE	
WEIGHT	

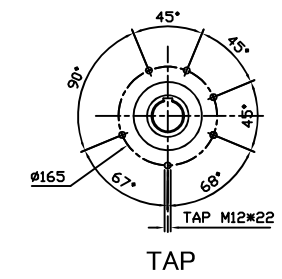
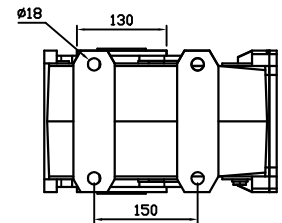
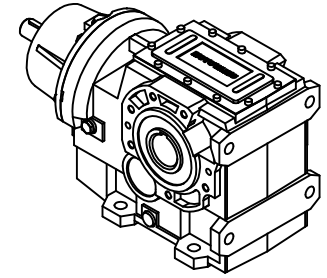
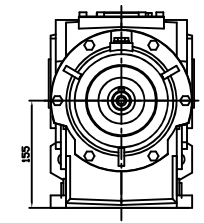
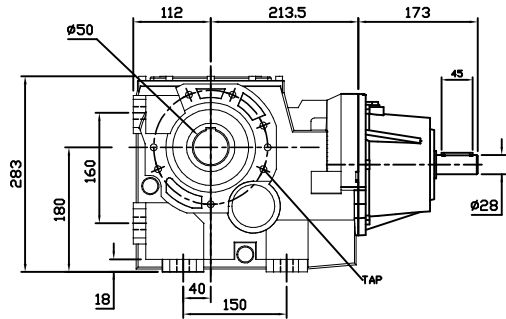
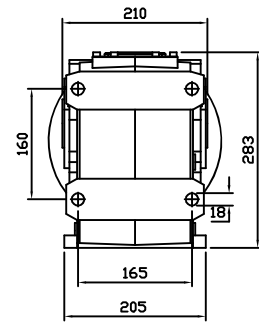
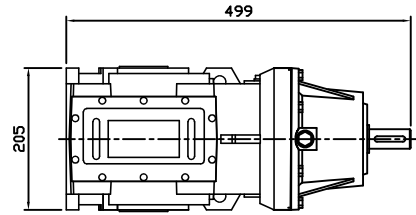

 (주)한국체인모터 Tel. 032-815-8888 Fax. 815-8020 www.hcmfa.com	PROJECT		MOTOVARIO					
	DRAWN	SEO Y.S	DATE		REV	A	SCALE	1:1
	CHECKED	KIM J.S	DATE		UNIT	MM	PAGE	-
	APPROVED	LEE J.Y	DATE		